

**MODEL SC112 DEMAND CONTROLLER
INSTALLATION INSTRUCTIONS**

Brayden Automation Corporation
1807 East Mulberry
Fort Collins, CO 80524

September, 1986
Manual V1.0
Document Number 09041-94102

CONTENTS

I.	Introduction	2
II.	Tools and Materials Required	2
III.	Pre-Installation System Check List	3
IV.	Locating the Control Unit	4
V.	Locating and Mounting the Relay Unit	6
VI.	Running the Control Cable	7
VII.	Wiring the Control Cable to C/D Unit	7
VIII.	Mounting the C/D Unit	8
IX.	Wiring the Control Cable to the Relay Unit	9
X.	Wiring the 115 VAC Power Supply to the Relay Unit	9
XI.	Installing and Wiring Current Transformers	11
XII.	Making up a Load Schedule and Assigning Load Assignments	12
XIII.	Wiring the Power Relays to Heat Circuits and Hot Water Heater	14
XIV.	Wiring the Power Relays to Dryer	16
XV.	Wiring the Power Relays to Heat Pumps and Air Conditioners	17
XVI.	System Checkout	19
XVII.	System Definition Programming	20
XVIII.	Wrap-Up	24

SC112 INSTALLATION MANUAL

I. INTRODUCTION

This manual contains instructions for installation, checkout, and programming the SAVERGY SC-112 Residential Electrical Demand Controller. IN ORDER TO ENSURE PROPER INSTALLATION AND WARRANTY COVERAGE, PLEASE READ THIS MANUAL THOROUGHLY BEFORE ACTUALLY PROCEEDING WITH THE WORK.

NOTE: All wiring must be installed in accordance with national and local electrical codes.

IMPORTANT: If you are going to connect the SAVERGY to a heat pump compressor or air conditioning compressor, ENSURE THAT YOU COMPLETE Section 1 "System Definition Programming".

II. TOOLS AND MATERIALS REQUIRED

A. Tools Required:

Flat blade type screwdriver
Phillips head screwdriver
Drywall Knife
Standard crimping tool (needed if optional crimp-on spade terminals are used).
AMP-CLAMP Current Sensor (if available)
Digital Volt Meter (required for troubleshooting only)

B. Material Required (not provided):

Four 1/4" x 2" lag bolts and/or appropriate hardware for mounting Relay Unit.

15 AMP single pole circuit breaker for demand controller 115VAC Power Supply.

Sufficient length of 4 Conductor Control Cable - SAVERGY P/N - 621-005, or BELDEN #9156 or equivalent. This cable has 4-#18 AWG Conductors, 2 twisted pairs 300V rated. THERMOSTAT WIRE IS NOT ACCEPTABLE.

Sufficient length of appropriate hookup wire (#14 AWG) to connect 115 volt power and ground from load center to Relay Unit.

Sufficient conduit, #10 AWG or #12 AWG wire (depending on load size), and associated hardware to connect load center to Relay Unit (if required).

III. PRE-INSTALLATION SYSTEM CHECK LIST

A. Parts Check

Check package contents to ensure it contains the following parts:

F/N	QUANTITY	DESCRIPTION
110-001	1	Control/Display Unit
115-102 (or) 115-104	2	Current Transformer—two of two types 200 amp Current Transformer (or) 400 amp Current Transformer
110-006 (or) 110-007 (or) 110-008	1	Relay Unit - one of 3 types MP-SM Mechanical Power Surface Mount (or) MP-FM Mechanical Power Flush Mount (or) MP-RT Mechanical Power Rain Tight
211-063	4	Crimp-on Spade Terminals (blue) (optional by request)
211-064	4	Crimp-on Spade Terminals (red) (optional by request)
140-039	4	Control/Display Unit Mounting Clips
451-014	4	Control/Display Unit Mounting Screws
671-003	1	Control/Display Unit Mounting Template
671-006	1	Owner's Manual w/ Warranty Registration Card
671-007	1	Installation Manual (this document)

NOTE: NOTIFY YOUR SAVERGY DEALER OR SYNERGETICS INTERNATIONAL, INC. IF ANY PARTS ARE MISSING.

B. System Overview

The Savergy SC112 Demand Controller system consists of three general pieces. They are: the control/display (C/D) unit, the relay unit, and the current transformers. Figure 1 on the following page shows the General System Configuration. The C/D unit mounts inside the home, usually in a general living area such as the kitchen, entry way, or family room. The relay unit mounts next to the breaker panel. The current transformers mount in the breaker panel around the main feeder cables.

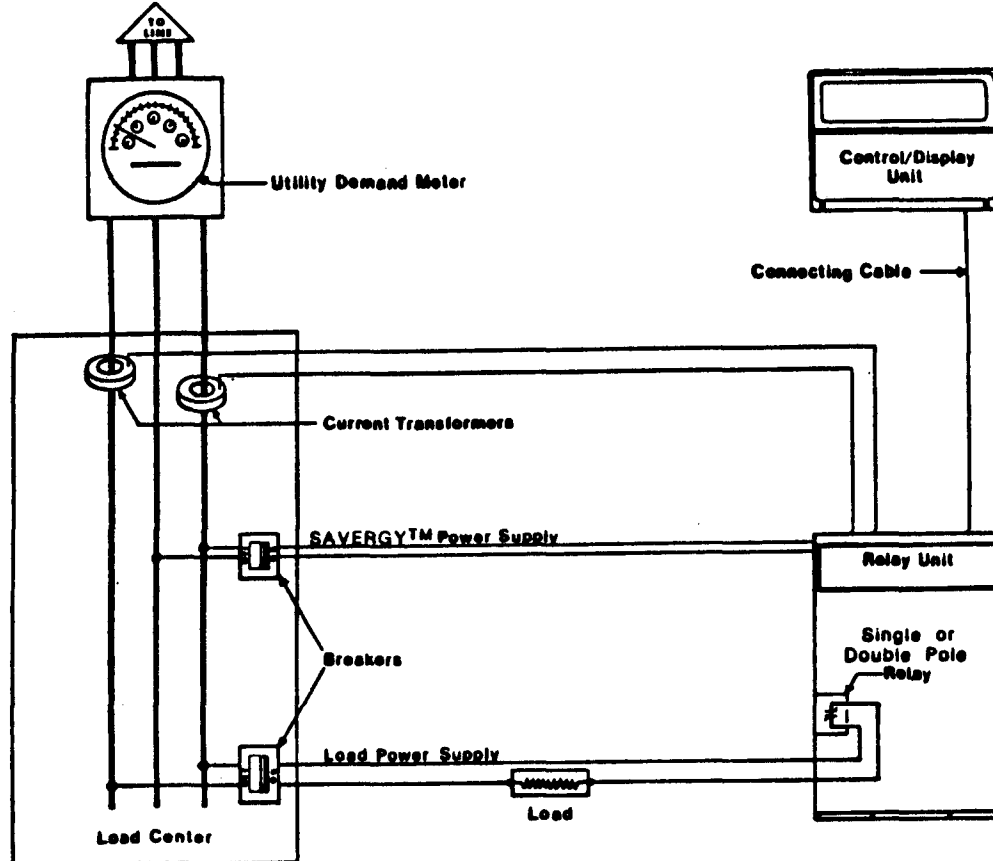

Figure 1: SC-112 Systems Diagram

Figure 1

IV. LOCATING THE CONTROL UNIT

1. Have the homeowner indicate their preference as to where the control/display unit should be mounted. The installer needs to look for a convenient and accessible way to run the control cable from the location of the relay unit to the location of C/D unit. This is normally done through an unfinished basement, crawl space, or an attic. The control cable is routed through an "outside" wall from the garage or wherever the breaker panel is located. It can alternately be run through an attic and then dropped down into an interior wall or strung through a crawl space and brought up through an interior wall.
2. The C/D unit **MUST NOT BE** mounted on an exterior wall or any wall which is exposed to the outside air or which may have drafts running through it. However, if there is absolutely no other way, and the C/D unit must be mounted on an "outside" or exterior wall which may have cold drafts running through it, **INSULATION MUST BE INSTALLED ABOVE AND BELOW THE MOUNTING POSITION SO THAT THE DRAFTS AND COLD TEMPERATURES WILL NOT AFFECT THE UNIT'S OPERATION.**
3. Follow the instructions on the control/display unit mounting template enclosed (P/N 671-003) to locate and mark the hole cutout and screw locations for the C/D unit as shown in Fig. 2, (page 4). Be careful to locate the hole between studs--C/D unit will only recess in wall correctly between studs because of the unit's depth.

4. Drill Screw hole FIRST with 1/8" drill.
5. Cut C/D mounting hole with drywall knife using caution and being careful not to make it too large.
6. Install the four C/D unit mounting clips.
7. Install the four C/D unit mounting clips (P/N 140-039) by pressing them onto the drywall. In most cases, they should stay in place by themselves. If necessary, pinch the sides together with a pair of pliers so that the clips grab the drywall snugly. Align the clips with the screw holes located and marked earlier.
8. DO NOT MOUNT C/D UNIT YET. CONTINUE ON TO SECTION V.

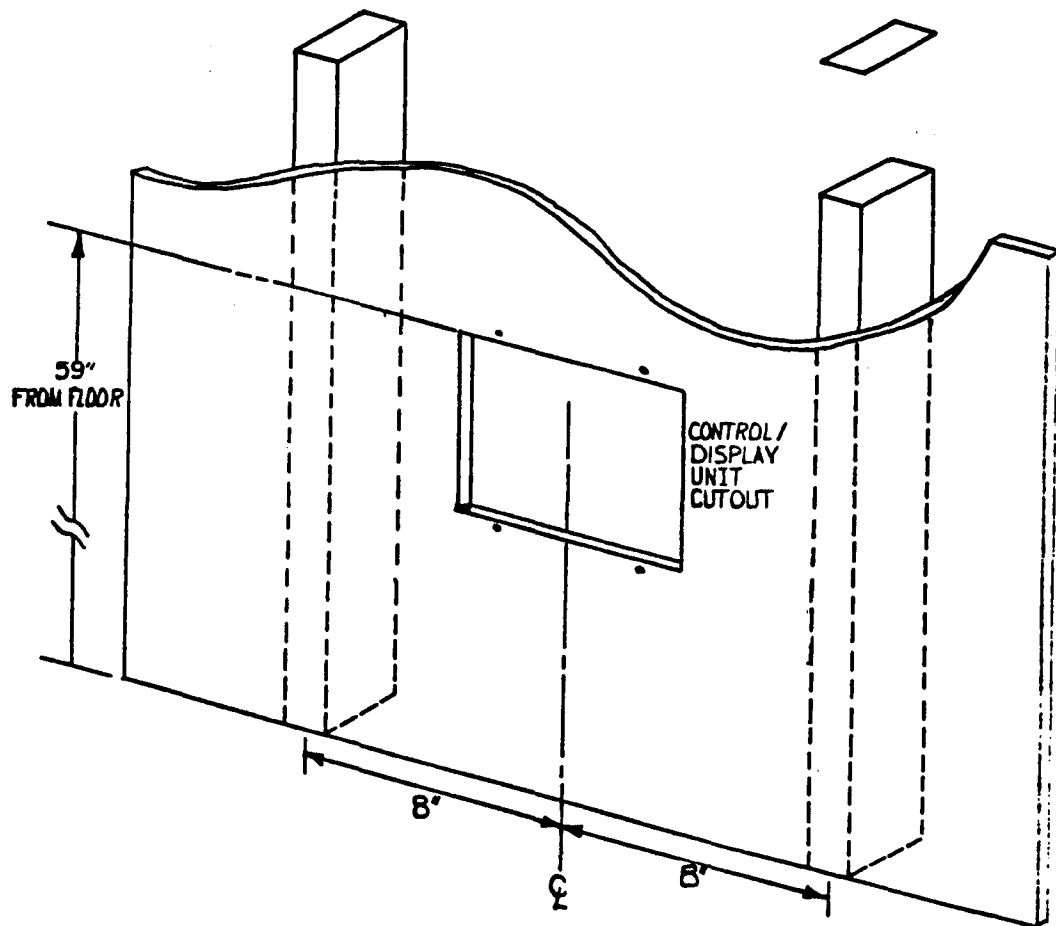

Figure 2 - Locating and Mounting the Control Unit

V. LOCATING AND MOUNTING THE RELAY UNIT

A. GENERAL RELAY UNIT TYPES.

1. SURFACE MOUNT RELAY UNIT (P/N 110-006) "SM"

This relay unit is equipped with a 15" x 12" x 4" NEMA 1 screw cover with a cover of the same size. It should be surface mounted on a finished wall or recessed in an unfinished stud wall such that future finishing will leave the unit flush mounted. Four screw holes (for 1/4" screws) are provided in each corner of the rear of the unit. Screws, lag bolts, or nails could be used to mount unit to adjacent studs. However, vibration, shock, and impact such as hammering must be avoided so as not to damage the delicate electronics enclosed.

2. FLUSH MOUNT RELAY UNIT (P/N 110-007) "FM"

Locate an area next to the breaker panel where a 15" x 12" hole in the drywall can be cut. Try to ensure that no wires or other obstructions are in the area where the relay unit will be mounted. Four screw holes (for 1/4" screws) are provided in each corner of the rear of the unit. Screws, lag bolts, or nails could be used to mount unit to adjacent studs. However, vibration, shock, and impact such as hammering must be avoided so as not to damage the delicate electronics enclosed. The flush cover provided measures 16-1/2" x 13-1/2".

3. RAIN TIGHT RELAY UNIT (P/N 110-008) "RT"

This relay unit is provided with a 12" x 8" x 4" NEMA 3R Raintight enclosure. Four holes for mounting are provided; two located directly below the chassis which hold the electronics, and two located at the bottom center of the enclosure. This unit is surface mounted with four 1/4" x 2" lag bolts or other appropriate hardware. However, vibration, shock, and impact such as hammering must be avoided so as not to damage the delicate electronics enclosed.

B. GENERAL MOUNTING PROCEDURE

1. Mount enclosure in an upright vertical position near the load center but no higher than 6' above the ground using four 1/4" x 2" lag bolts and appropriate mounting hardware. The chassis inside the Relay Unit containing the printed circuit board must be on the upper part of the box. (Mounting bolts not provided.)

CAUTION: Outdoor enclosures (NEMA 3R) should be mounted where they will receive the least possible amount of direct sunlight. Flush Mount and Surface Mount enclosures (NEMA 1) must be mounted indoors only.

2. Connect the Relay Unit to the load center with metal conduit to be run from the appropriate knockout(s), if required. A 1-1/4" conduit must be installed to accommodate up to sixteen load wires size #10-#12 AWG and four #18 AWG current transformer wires and three #14 AWG wires for 115V power to unit. A separate conduit may also be required for the control cable (0.375" diameter).

VI. RUNNING THE CONTROL CABLE

1. After the location of the Control/Display Unit and the Relay Unit have been determined and the Relay unit mounted, run the control cable from the Relay unit to the C/D unit, leaving sufficient cable length for a 12" service loop at both the C/D unit and the relay unit. DO NOT RUN CONTROL CABLE NEXT TO OR PARALLEL TO ANY HIGH VOLTAGE (CLASS I) WIRES, IF POSSIBLE.

CAUTION: CONTROL CABLE MUST NOT RUN THROUGH THE MAIN BREAKER PANEL.

VII. WIRING THE CONTROL CABLE TO CONTROL/DISPLAY UNIT

1. Remove cover from C/D unit by pulling the cover outward first on one side and then the other. Be extremely careful not to damage the hinge posts which protrude out approximately 1/2" on each side of the bottom front of the unit.
2. Pass the four wires of the control cable through the square hole in the rear of the enclosure and through the 3/8" diameter hole in the printed circuit board (PCB). Strip approximately 1/2" off of each wire end.
3. The Control Cable consists of two twisted pairs. These are a Black/Red pair and a Black/White pair. To guarantee proper operation and noise immunity, when wiring these pairs to the Control/Display board, THE BLACK WIRES MUST NOT BE CROSSED OR MIXED UP, even though the black wires are connected together at the Data/Link (D/L) printed circuit board in the Relay unit. Connect the wires as shown in Table 1 and in Figure 3 on the following page.

TABLE 1 - CONTROL/DISPLAY UNIT CONNECTIONS

TERMINAL #	WIRE COLOR	PAIR COLOR
CD1	RED	RED/BLACK
CD2	WHITE	WHITE/BLACK
CDC3	BLACK *	RED/BLACK
CDC4	BLACK	WHITE/BLACK

* Some cable is available with a red strip on the black wire for easier identification.

4. Ensure the Red/Black pair is connected to the top two screw terminals. Red to terminal CD1. Black to terminal CDC3. The White/Black pair is connected to the bottom two terminals. The White to terminal CD2. Black to terminal CDC4. Refer to Figure 3 or wiring diagram on Relay Unit cover. After wires are attached, double check to make sure that wires are connected to the proper terminals and that there are no stray strands of wire which may short any of the terminals to each other or any part of the C/D PCB.

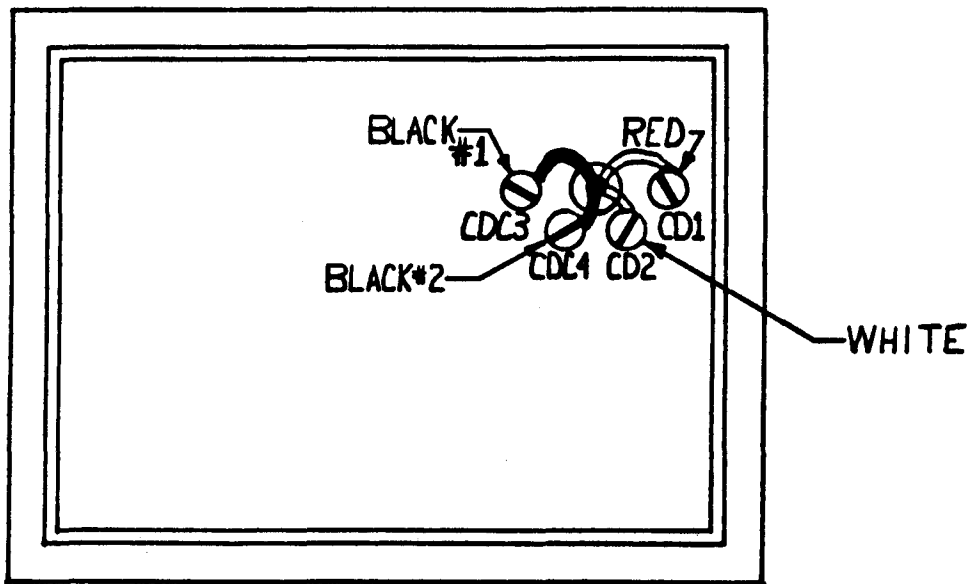

Figure 3 - Wiring the Control Cable

VIII. MOUNTING THE C/D UNIT

1. After all wire connections have been made and screws tightened, pull excess cable back through the rear of the C/D unit so that cable does not stick up.
2. Place the C/D unit in the cutout hole and align the four mounting holes in the plastic housing so they line up with the four mounting clips installed earlier.
3. With the four #6 X 1-1/4" Flat head sheet metal screws provided (P/N 451-Ø14), use a Phillips head screwdriver to insert the screw through the plastic housing, through the hole in the short side of the C/D unit mounting clips, through the drywall and into the small hole on the other side of the mounting clip. The sheet metal screw will thread through the small hole and tighten the C/D unit enclosure to the wall. Repeat this procedure with the other three screw's positions.
4. When all four screws have been installed, the C/D unit should be securely fastened to the wall. Line up the front cover bezel assembly with the enclosure, making sure that the hinge posts line up with the slots that they insert into. Press the assembly gently onto the enclosure. You will hear and feel it snap into place if it has been aligned correctly.
5. Control/Display unit installation is now complete.

IX. WIRING THE CONTROL CABLE TO THE RELAY UNIT

1. Run cable through an unused knockout at bottom of Relay Unit and secure with cable clamp. Leave approximately 6" to 12" of control cable in the relay unit for a service loop.

NOTE: CONTROL CABLE MUST NOT RUN THROUGH LOAD CENTER

2. Strip back the outer jacket of the control cable about 6 inches.
3. Attach the Control Cable to the Relay Unit Data/Link PCB as follow
 - a. Run the cable up the right side of the relay box, through the cable clamp on the bottom side of the chassis and up through the hole on the front of the chassis with the nylon grommet installed.
 - b. Strip each conductor back 3/8" and crimp on three spade terminals (optionally supplied with the unit) with a standard crimping tool. THE BLACK WIRES MUST BE DOUBLED UP ON ONE BLUE SPADE AT THIS END. RED SPADE TERMINALS SHOULD BE CRIMPED SEPARATELY ONTO EACH--THE WHITE WIRE AND THE RED WIRE.
 - c. Connect spade terminals (or bare wires) to terminal strip in lower right hand corner of Data/Link printed circuit board as shown in Figure 4 (on page 10) or the wiring diagram on Relay Unit inside cover or in TABLE 2.

TABLE 2 - CONTROL CABLE CONNECTIONS TO RELAY UNIT

TERMINAL #	WIRE COLOR	PAIR COLOR
CD1	RED	RED/BLACK
CD2	WHITE	WHITE/BLACK
CDC3 & 4	BLACK	RED/BLACK
CDC3 & 4	BLACK	WHITE/BLACK

BOTH BLACK WIRES CONNECT TO TERMINAL # CDC3 & 4

X. WIRING THE 115 VAC POWER SUPPLY TO THE RELAY UNIT

1. Install a single pole 115 volt 15 amp circuit breaker in the breaker panel for the SAVERGY and mark it "SAVERGY".

CAUTION: ENSURE THE 15 AMP CIRCUIT BREAKER IS OFF BEFORE CONNECTING SUPPLY LINE.

2. Run a 115 volt supply line (14 awg copper, 600 volt insulation, with ground line) from the separate 115 volt, 15 amp single-pole breaker just installed in the load center into the relay unit through the conduit.
3. Strip supply leads back 3/8" at Relay Unit and attach two blue spade terminals (optionally supplied with the unit) with standard crimping tool, if desired.

4. Connect the wires to terminals T1 and T2 in the lower left hand corner of the Data/Link printed circuit board as shown in Figure 4 or on the wiring diagram on the inside cover of the Relay Unit.
5. Connect the ground line to the ground bus in the load center and to the green grounding screw on the chassis at the lower right hand side of T1 and T2.
6. This completes wiring of the 115VAC supply to the "SAVERGY" unit.

CAUTION: LEAVE BREAKER OFF UNTIL INSTALLATION IS COMPLETE.

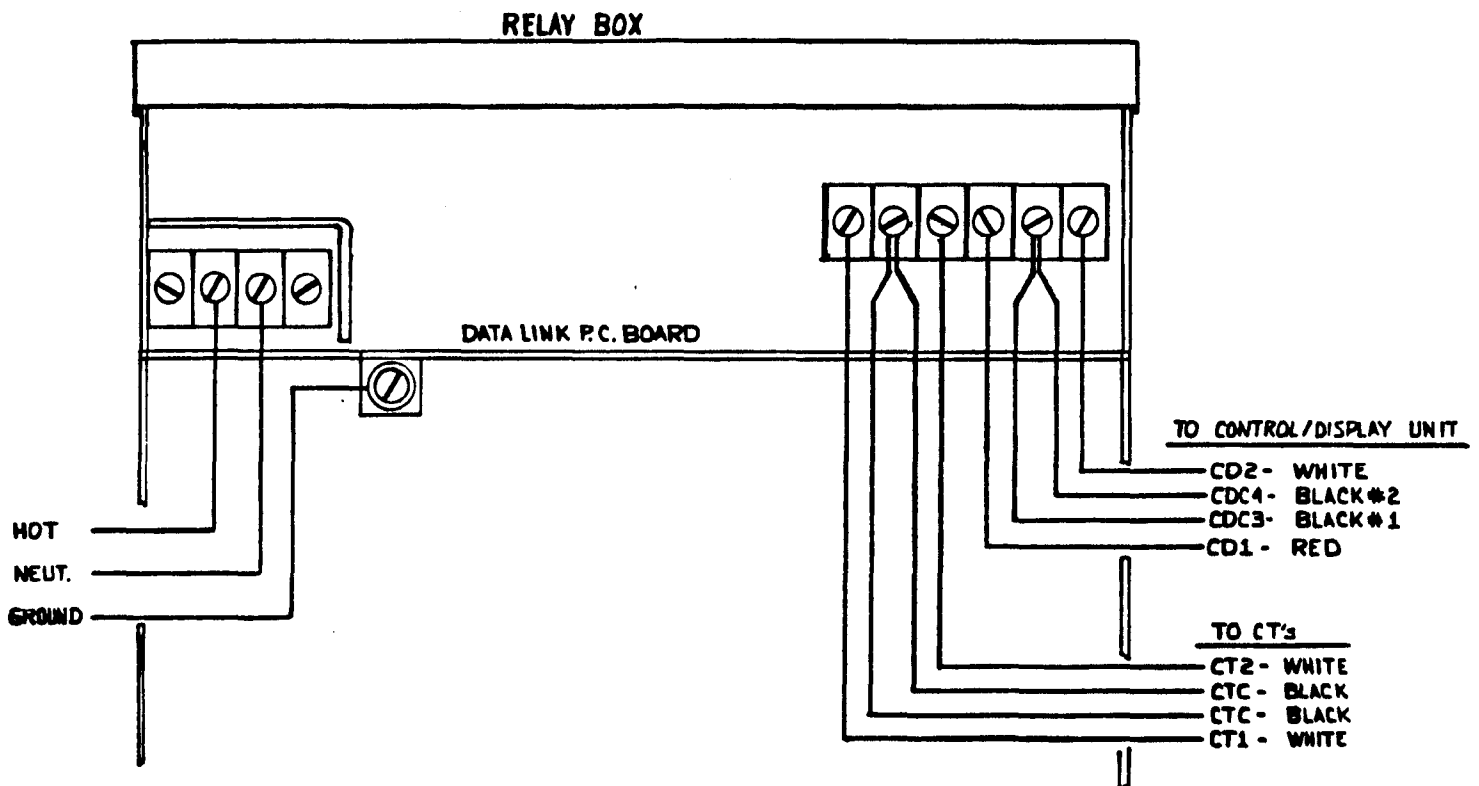

Figure 4

XI. INSTALLING AND WIRING CURRENT TRANSFORMERS

CAUTION: INSTALLATION OF CURRENT TRANSFORMERS MAY NEED TO BE COORDINATED WITH THE LOCAL ELECTRIC COMPANY.

NOTE: Some electrical codes require that CURRENT TRANSFORMERS be mounted in a separate enclosure.

- 1. DISCONNECT main power to the load center panel by removing the meter by a main disconnect switch if possible.
- 2. When power is off, install current transformers around main feeder cables between the meter and the main breaker as shown in the wiring diagram on Relay Unit or Figure 1. The current transformers must be installed in the same direction.

NOTE: Ensure that the side of the current transformers from which the wires emerge is placed POINTING AWAY from the main breaker.

- 3. Run current transformer leads into Relay Unit via the conduit if current transformers are installed within breaker panel and cut the black/white twisted pair of each to a sufficient length to connect to the 6 position terminal strip on the right hand side of the Data/Link printed circuit board. Leave about 8-12" extra. DO NOT RUN LEADS NEXT TO OR PARALLEL TO HIGH VOLTAGE (CLASS I) WIRING, IF POSSIBLE.
- 4. Strip each conductor back 3/8" and if desired crimp on three spade terminals (optionally supplied with the unit) with a standard crimping tool. THE BLACK WIRES MUST BE DOUBLED UP IN ONE BLUE SPADE TERMINAL. A RED SPADE SHOULD BE CRIMPED ON TO EACH WHITE WIRE.
- 5. Connect black and white wires to 6 position terminal strip as follows:

TABLE 3 - CURRENT TRANSFORMER CONNECTIONS TO RELAY UNIT

TERMINAL #	WIRE COLOR
CT1	WHITE-from CT1
CTC	BLACK-from CT1 and BLACK-from CT2
CT2	WHITE-from CT2

NOTE: It makes no difference which white wire is connected to terminals CT1 and CT2.

- 6. Route current transformer wires and the control cable through the wire clamps located on bottom right of chassis. Snap clamps together to secure wires leaving approximately 1" slack between the terminals and clamp.
- 7. For flush mount unit, route current transformer wires and the control cable through a separate knockout. Secure with a metal cable clamp at the knockout to provide strain relief.
- 8. This completes installation and wiring of the current transformers.

XII. MAKING UP A LOAD SCHEDULE AND ASSIGNING LOAD ASSIGNMENTS.

NOTE: The Relay Unit is shipped from the factory ready to operate under the Rotate Load Control Strategy with no preset minimum on/off time for circuits 1, 2, or 3. Changes in load control strategy and minimum on/off times for circuits 1, 2, and/or 3 may be made through the front panel of the Control/Display Unit. However, all components of the SC-112 must first be installed and verified operating properly as set forth in Section 16 of this manual. Instructions for changing load control strategy and minimum on/off times are provided in Section 17 of this manual or may also be obtained from the factory or a SAVERGY Representative.

CAUTION: ENSURE ALL CIRCUITS TO BE CONTROLLED ARE TURNED OFF AT THE APPROPRIATE BREAKER IN THE LOAD CENTER BEFORE PROCEEDING WITH ANY WIRING

WARNING: When controlling heat pump and air conditioning compressor loads, minimum off time of at least 5 minutes must be programmed. Minimum off times are available only on circuits 1, 2, and 3. (Some manufacturer's may require longer minimum OFF times for compressor protection. CHECK WITH MANUFACTURER.) THEREFORE, compressors must be connected to circuits 1, 2, and 3 in that order. In other words, if you have one compressor, it must be connected to Circuit #1; If you have two compressors, they must be on Circuits #1 and #2; and If you have three compressors, they must be connected to Circuits #1, #2, and #3. When installation is complete, minimum on and off times can be programmed in Section 17.

A. Prepare a load schedule identifying which loads will be connected to which circuits. THE FOLLOWING ARE EXAMPLES ONLY. YOUR SITUATION MAY BE DIFFERENT AND REQUIRE A VARIATION OF THESE EXAMPLES. CONTACT YOUR SAVERGY REPRESENTATIVE OR THE FACTORY FOR APPLICATIONS ASSISTANCE.

1. FOR ELECTRIC BASEBOARD OR RADIANT CEILING HEAT HOMES: EXAMPLE ONLY

It is recommended that for best results with these types of heating systems, the loads be connected as follows:

CIRCUIT #:	LOAD:	LOAD CONTROL STRATEGY:
1	DRYER	FIXED/ROTATE
2	HOT WATER HEATER	
3	HEAT #1	
4	HEAT #2	
5	HEAT #3	
6	HEAT #4	
7	HEAT #5	
8	HEAT #6	

2. FOR HOMES WITH HEAT PUMPS WITHOUT COMPRESSOR CONNECTED: EXAMPLE ONLY

It is recommended that the heat pump compressor NOT be connected to the demand controller in heating climates. This is recommended because the efficiency of a heat pump decreases dramatically as the

outside temperature decreases. Consequently, turning on and off a heat pump compressor in cold outside temperatures is not advised. Therefore, the backup electric forced air furnace is the major heating system component that needs to be controlled. Electric furnaces usually have from three to five stages of heat which is controlled by what most manufacturers call a "sequencer". The sequencer uses a fixed priority type scheme to turn on and off these heat strips as required. Heat strips should be controlled individually with remote relays on the 240 VAC line. (See Section 15.) The following general load schedule is typical for this application:

CIRCUIT #:	LOAD:	LOAD CONTROL STRATEGY:
1	HEAT #1	FIXED PRIORITY
2	DRYER	
3	HEAT #2	
4	HOT WATER HEATER	
5	HEAT #3	
6	HEAT #4	
7	HEAT #5 (IF NEEDED)	
8	HEAT #6 (IF NEEDED)	

This schedule may be altered as necessary to suit the needs of the particular home and user. THIS IS AN EXAMPLE ONLY. For application assistance, contact your SAVERGY representative or SYNERGETICS INTERNATIONAL, INC.

3. FOR HOMES WITH HEAT PUMPS WITH COMPRESSOR CONNECTED: EXAMPLE ONLY.

When assigning loads for homes with heat pumps or air conditioners with the compressor connected, compressors must be connected to Circuits 1, 2, and/or 3 as discussed above. Here are two examples:

CIRCUIT #:	EXAMPLE 1	EXAMPLE 2	LOAD CONTROL STRATEGY:
	LOAD SCHEDULE A	LOAD SCHEDULE B	
1	COMPRESSOR (A/C)	COMPRESSOR A	FIXED PRIORITY
2	HEAT #1	COMPRESSOR B	
3	DRYER	DRYER	
4	HEAT #2	WATER HEATER	
5	WATER HEATER	HEAT #1A	
6	HEAT #3	HEAT #1B	
7	HEAT #4	HEAT #2A	
8	HEAT #5(if needed)	HEAT #2B	

THIS SCHEDULE MAY BE ALTERED.

CIRCUITS WITH COMPRESSORS MUST HAVE MINIMUM OFF AND MINIMUM ON TIME PROGRAMMED IN. SEE SECTION 17 FOR SYSTEM DEFINITION PROGRAMMING PROCEDURE.

B. USE THE FORM BELOW TO MAKE UP THE LOAD SCHEDULE FOR THIS APPLICATION:

	LOAD NAME
CIRCUIT #1
CIRCUIT #2
CIRCUIT #3
CIRCUIT #4
CIRCUIT #5
CIRCUIT #6
CIRCUIT #7
CIRCUIT #8

XIII. WIRING THE POWER RELAYS TO HEAT CIRCUITS AND HOT WATER HEATER

1. TURN OFF ALL BREAKERS WHICH ARE GOING TO BE CONNECTED TO.
2. Heat circuits and the hot water heater are connected to the breaker panel as shown in FIG. 5. Both wires are connected to a 220VAC double pole breaker.

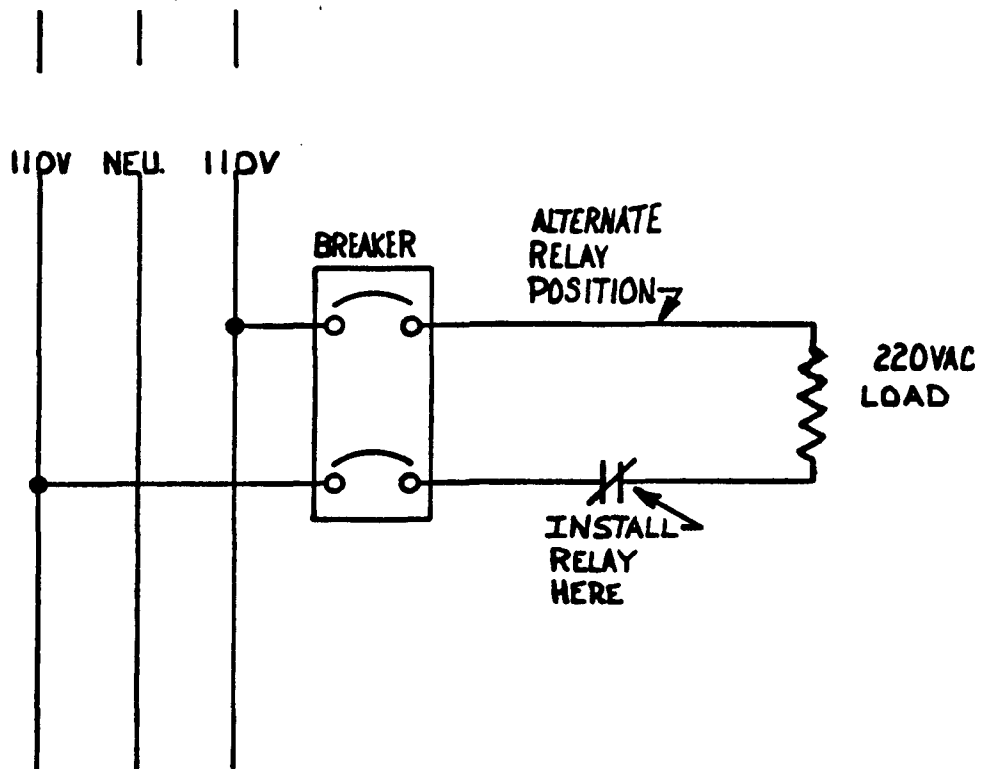

Figure 5

3. The relay is inserted in series with the load on one side of the load only as shown in FIG. 5 on the previous page.
4. Remove either ONE of the two wires from each load and wire-nut this lead to a short length of #10 or #12 AWG (depending on load size) wire which runs into the Relay unit. Wire-nut this length of wire to one lead of the relay's contact. With another short length of the appropriately sized wire, wire-nut it to the other lead of the relay's contact. Connect the other end of this short length of wire back to the circuit breaker's terminal where the wire was originally removed as shown in FIG. 6. below.

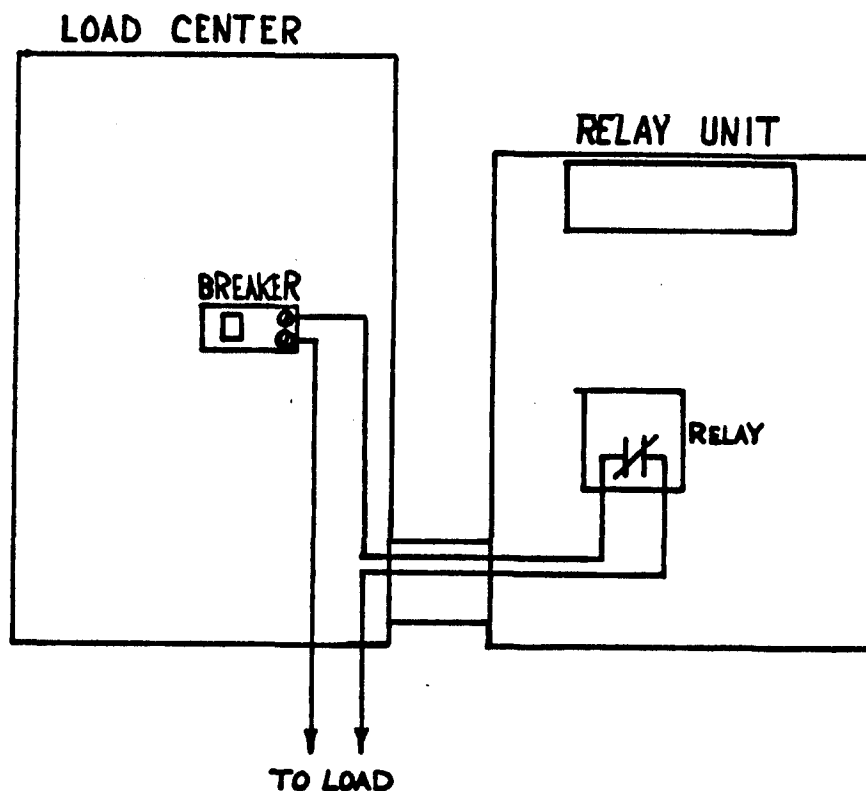

Figure 6

5. Repeat this procedure for the remainder of the heat circuits and hot water heater(s). Heat circuits are normally on 20 amp circuit breakers and require #12 AWG wire. Hot water heaters are normally on a 30 amp breaker and require #10 AWG wire. All SAVERGY relays are equipped with #10 AWG RED lead wire.
6. This completes wiring of power relays to heat circuits and to the hot water heater.

XIV. WIRING THE POWER RELAYS TO DRYER

1. TURN OFF ALL BREAKERS WHICH ARE GOING TO BE CONNECTED TO.
2. The dryer is connected to the breaker panel as shown in FIG. 7. Both wires are connected to a 30 Amp, 220 VAC double pole breaker.
3. The relay is inserted in series on the heating element side of the load only as shown in FIG. 7. The motor of the dryer is NOT connected. Care must be taken to insure that the dryer is connected properly since improper connection MAY damage dryer.

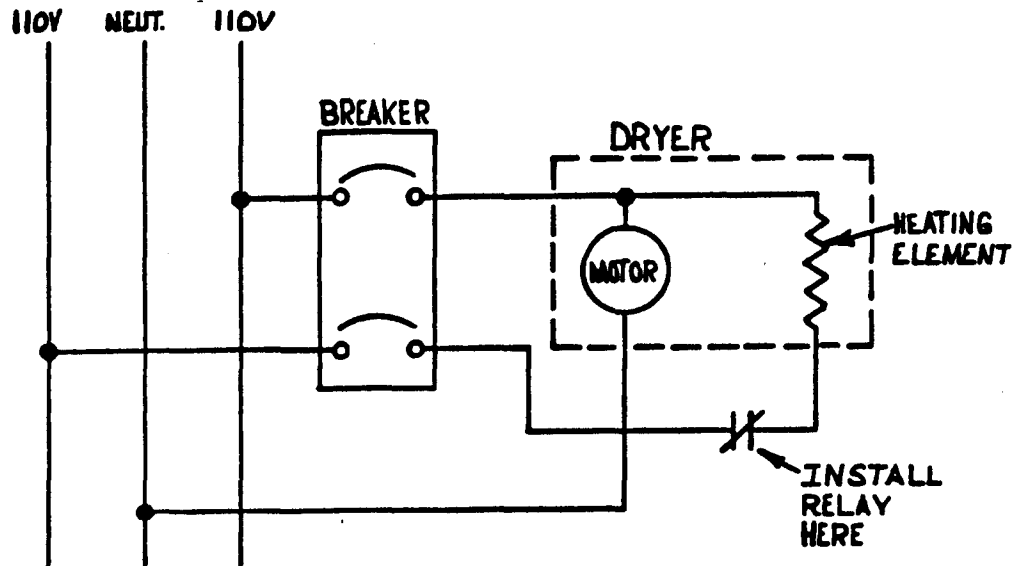

Figure 7

4. Remove ONE of the two wires from the dryer and suspend this wire such that it will not short to anything. Turn on dryer to see if the motor starts. If so, this is the correct wire to attach to the power relay. To verify this, turn off dryer, reattach this wire to the breaker and remove the other wire from the breaker. Start dryer again and this time the dryer's motor should NOT start. If it does (dryer starts with either wire disconnected), your dryer may require some internal wiring modifications before it can be connected to the load controller. CONTACT DRYER MANUFACTURER OR CONSULT DRYER WIRING DIAGRAM.
5. Remove the proper wire from the breaker (with the proper wire removed, the dryer motor SHOULD start. Run two short lengths of #10 AWG wire between the breaker panel and the relay unit. Wire-nut the disconnected length of wire to one of the short lengths of wire in the breaker panel. Wire-nut the other end of this wire to one red lead of the relay's contact. From the relay's other red lead the contact, wire-nut this to the other short length of wire that returns into the breaker panel. Connect the other end of the wire back to the dryer's circuit breaker as shown in FIG. 8 on the following page.
6. This completes wiring of power relays to the dryer.

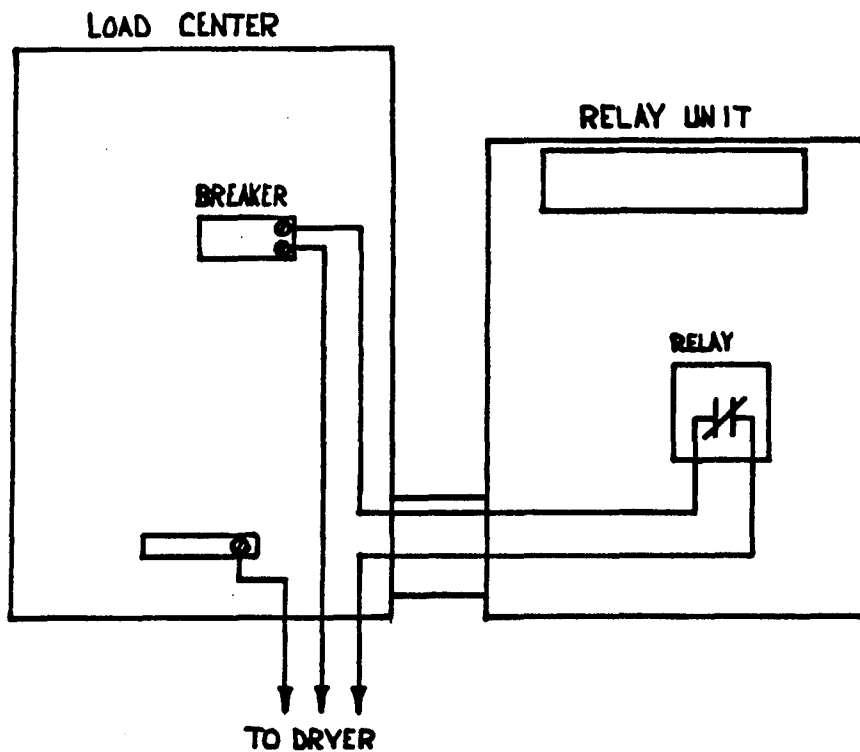

Figure 8

XV. WIRING THE POWER RELAYS TO HEAT PUMPS AND AIR CONDITIONERS

1. TURN OFF ALL BREAKERS WHICH ARE GOING TO BE CONNECTED TO.
2. Connecting air conditioners and/or heat pump compressors to the SAVERGY unit is normally accomplished by inserting a relay in series with the low voltage 24 VAC thermostat control loop as shown in FIG. 9 below. (GENERALIZED DRAWING).

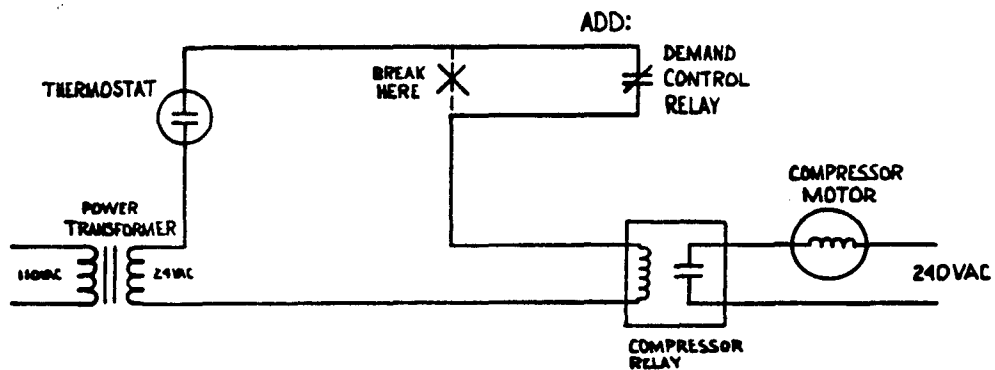

FIG. 9

3. This completes wiring of power relays to the heat pump or air conditioner thermostat loops.

B. Connecting the Demand Controller to an Electric Furnace

When connecting an electric furnace to the demand controller, the simplest and most economical method is to install a remote relay box at the furnace. This relay box usually contains 3 to 6 relays for connection to each individual heat strip in the furnace. These relays are connected to the main relay unit by means of paired cable, normally one pair per relay. For example, for 4 remote relays, a #18 AWG eight conductor cable is required. Twisted pairs are recommended for this application for convenience. Relay connector pigtails (Optional) should be used with the unit for connection at the main relay unit to the multi-conductor cable. At the remote relay unit, relay leads are wire nuted to the multi-conductor as shown in Figure 10 below.

1. Determine the staging sequence of the electric furnace. For example, many furnaces have 3 stages of heat. Stage #1 consists of two 5 KW heating elements. Stage #2 many times also consists of two 5 KW heating elements. And finally, Stage #3 has one 5 KW heating element.

2. Wire the heating elements of Stage #1 to the first two available demand controller relays. See Sec. XII, part 2-B on page 17 for an example. The heating elements, Heat 1A and Heat 1B are wired to relays #1 and #3. Heating elements #2A and 2B are wired to Relays #5 and #6. Heating element #3 is wired to relay #7. The dryer would be wired to Relay #2 and hot water heater to Relay #4.

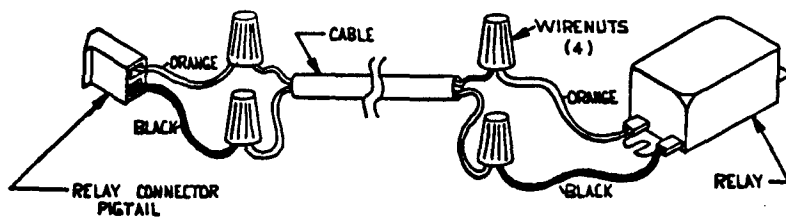
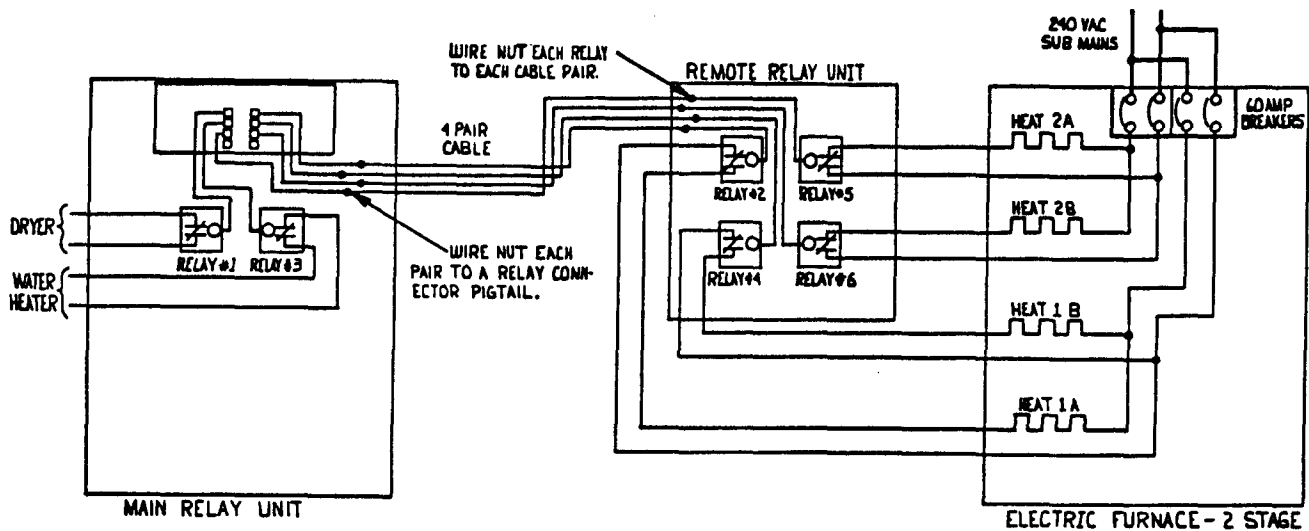

Figure 10

3. Run the multi-conductor cable from the main relay box to the remote relay box. Use the optional Relay connector pigtaills (P/N 125-900) to connect each conductor pair to the Relay Output Jacks in the main relay unit. In the remote relay unit, wire nut the opposite end of these conductors to the relay. Make sure the COLOR CODE is observed. Orange wire of each relay should go back to the top pin of each 2 pin relay output jack.

4. Do the remaining relays similar to the first making sure that each relay has it's own pair of wires. DO NOT COMMON ANY WIRES TOGETHER.

NOTE: THIS IS AN EXAMPLE ONLY. YOUR APPLICATION MAY BE DIFFERENT.
Consult Synergetics International of your Savergy Representative for additional information or applications assistance.

XVI. SYSTEM CHECKOUT

1. Prior to Test:
 - a. Turn off ALL breakers in the load center.
 - b. REPLACE COVER ON RELAY UNIT. Do not tighten screws.
 - c. Be sure all thermostats or switches for controlled loads are on.
2. Conduct Initial Operation Test
 - a. Insure all breakers in the load center are off.
 - b. Turn on the 15 Amp 115VAC breaker labeled "SAVERGY DEMAND CONTROLLER".
 - c. Control/Display unit should turn on, beep once, and light up with the factory set "6" in the "KW Demand Limit" window. If unit fails to light up, TURN POWER OFF IMMEDIATELY. CHECK WIRING AND CONNECTIONS TO MAKE SURE THAT THE UNIT IS WIRED PROPERLY. Try powering unit up again as before. If problems still arise, call your SAVERGY Representative or Synergetics International, Inc.
 - d. All eight "Circuits On" indicator lights should come on and all go off within about 30 seconds after unit is turned on. This is part of the system's initialization routine. Then every two minutes one circuit indicator light will come on.
 - e. There should be no obvious shorting in the relay unit.
3. Conduct Power Off Test
 - a. Turn off unit at the breaker panel and wait 10 seconds, then turn unit back on. Wait until "Circuits On" lights go out.
 - b. Set demand limit to 1 KW according to the instructions on the front panel of the Control/Display Unit.
 - c. Place actual demand in the "instantaneous" mode.
 - d. Turn on a large (greater than 1 KW) uncontrolled load such as the kitchen range. Leave all controlled loads off.
 - e. Within 60 seconds, all "Circuits On" lights on the Control/Display unit should turn off and the alarm buzzer should sound.
 - f. Increase the demand limit setting 1 KW at a time until the alarm buzzer stops. The demand limit should be slightly larger than the uncontrolled load. This verifies that the unit is measuring power properly.
 - g. Turn off uncontrolled load.

4. Conduct Power On Test

- a. Insure all breakers in the load center are off except for the 15AMP "SAVERGY DEMAND CONTROLLER" breaker. Observe the disk of the KW hour meter to be sure that it is turning very slowly due only to the power consumed by the SAVERGY demand controller unit.
- b. Set the demand limit to a number 2-3 times higher than the estimated demand limit of the installation.
- c. This demand limit will allow all of the circuits to be turned on in about 16 minutes-(2 minutes per circuit).
- d. Turn on each controlled load circuit, one at a time. The KW hour meter disk should speed up as each load is turned on. This verifies that all relays are actually closed and each circuit is providing power to the load.

CAUTION: DO NOT LEAVE CONTROLLED LOADS ON FOR MORE THAN A FEW MINUTES AS THIS MAY CAUSE THE ELECTRIC METER TO REGISTER A HIGH DEMAND PEAK.

NOTE: If minimum on and off times have been programmed into the unit, there loads controlled under these times will switch only when the appropriate time intervals have elapsed.

5. Restore household loads to the desired condition. The circuit breaker marked "SAVERGY DEMAND CONTROLLER" should be left on with desired demand limit of "6" KW set into the Control/Display unit.











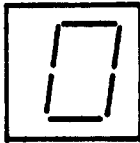
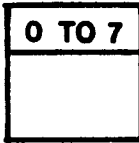

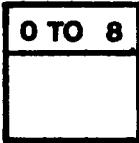
XVII. SYSTEM DEFINITION PROGRAMMING

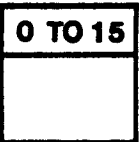
- A. The system definition programming mode is designed to give the user the power and flexibility to "tailor" the controller's operation to the user's exact requirements. In this mode, the user programs the controller and "tells" it: 1.) how many relays are connected to the system; 2.) what load control strategy it will operate under; and 3.) the minimum on and minimum off times for loads 1, 2, and 3. System definition programming mode consists of a series of EIGHT "questions", numbered from 0 to 7 in the "Demand Limit" window. The "answer" or data to each question is programmed into the "Actual" window.

Step 1: To enter the system definition mode depress the "BUZZER VOLUME" and "RESET PEAK" keys for about 5 seconds. (The System definition programming mode should not be entered while the controller is in its initialization mode--during the first 30 seconds after power up.) The controller will turn off all "Circuits On" LED indicator lights as well as the instantaneous, average, or peak light. A "0"(zero) will appear in the "Demand Limit" window.

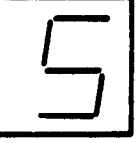
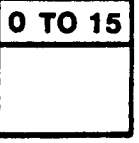
To change the LIMIT Number, depress the "Increase" key. Depressing this key will advance the system definition mode to the next question

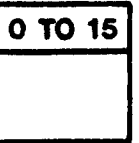
To change the ACTUAL Number, depress the "Demand Limit" key. Depressing this key will advance the data or "answer" to the question which appears in the "LIMIT" display. The numbers will scroll up from 0 to 15, and roll back over to "0" again. Hold this key down until the desired number is shown in the "ACTUAL" display. Then release key.

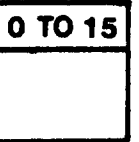
	LIMIT DISPLAY	ACTUAL DISPLAY	SETTING RANGE Desire Setting
Step 2: DEMAND LIMIT DISPLAY = 0 Set the NUMBER OF CIRCUITS NOT CONNECTED. Take the number of relays installed in the relay unit and subtract from 8. If 8 relays installed: $8 - 8 = 0$ 6 relays installed: $8 - 6 = 2$			
Step 3: DEMAND LIMIT DISPLAY = 1 Set the NUMBER OF ROTATING LOADS. This sets the controller's load control strategy. For example: 0 = no rotating loads (fixed priority) 8 = all rotating loads (rotating) 5 = 5 rotating loads with 3 loads (circuits 1, 2, & 3) in fixed priority (See page 10 of the Homeowner's Manual) NOTE: Even though some circuits may have been disabled in question #0, you must account for all 8 loads in this question.			
Step 4: DEMAND LIMIT DISPLAY = 2 Set Circuit 3 Minimum Off Time (minutes)			
Step 5: DEMAND LIMIT DISPLAY = 3 Set Circuit 2 Minimum Off Time (minutes)			
Step 6: DEMAND LIMIT DISPLAY = 4 Set Circuit 1 Minimum Off Time (minutes)			
Step 7: DEMAND LIMIT DISPLAY = 5 Set Circuit 3 Minimum On Time (minutes)			
Step 8: DEMAND LIMIT DISPLAY = 6 Set Circuit 2 Minimum On Time (minutes)			
Step 9: DEMAND LIMIT DISPLAY = 7 Set Circuit 1 Minimum On Time (minutes)			
Step 10: Depress the "Increase" key until the normal CONTROL MODE is resumed. The preset demand limit will return under the "LIMIT" window. The instantaneous light will also come back on.			

System Definition Programming is now complete.

B. EXAMPLES OF PROGRAMS

1. For the load schedule shown in Section 12, part A-1, the following system definition program is recommended:

Selected Load Control Strategy: Fixed/Rotate Combination
System Assumptions: 8 Relays installed
Heating System: 6 Circuits, Electric Baseboard or Radiant Ceiling
Hot Water Heater and Dryer Connected to Unit. 2 Circuits.

"LIMIT" DISPLAY		"ACTUAL" DISPLAY
QUESTION #	QUESTION:	ANSWER:
0	# of loads not connected:	0
1	# of rotating loads:	6
2	Ckt. #3 Min. Off Time	0
3	Ckt. #2 Min. Off Time	0
4	Ckt. #1 Min. Off Time	0
5	Ckt. #3 Min. On Time	0
6	Ckt. #2 Min. On Time	0
7	Ckt. #1 Min. On Time	0

2. For the load schedule shown in Section 12, part A-2, the following system definition program is recommended:

Selected Load Control Strategy: Fixed Priority
System Assumptions: 6 Relays installed
Heating System: 4 Circuits, Heat Pump with Electric Forced Air Furnace.
Hot Water Heater and Dryer Connected to Unit. 2 Circuits.
Heat Pump Compressor NOT Connected.

"LIMIT" DISPLAY		"ACTUAL" DISPLAY
QUESTION #	QUESTION:	ANSWER:
0	# of loads not connected:	2
1	# of rotating loads:	0
2	Ckt. #3 Min. Off Time	0
3	Ckt. #2 Min. Off Time	0
4	Ckt. #1 Min. Off Time	0
5	Ckt. #3 Min. On Time	0
6	Ckt. #2 Min. On Time	0
7	Ckt. #1 Min. On Time	0

3. For the load schedule shown in Section 12, part A-3A, the following system definition program is recommended:

Selected Load Control Strategy: Fixed Priority
 System Assumptions: 7 Relays installed
 Heating System: 5 Circuits, Heat Pump with Electric Forced Air Furnace.
 Hot Water Heater and Dryer Connected to Unit. 2 Circuits.
 Heat Pump Compressor Connected to Unit on Circuit #1.

"LIMIT" DISPLAY		"ACTUAL" DISPLAY	
QUESTION #	QUESTION:	ANSWER:	
0	# of loads not connected:	1	
1	# of rotating loads:	0	
2	Ckt. #3 Min. Off Time	0	
3	Ckt. #2 Min. Off Time	0	
4	Ckt. #1 Min. Off Time	4	
5	Ckt. #3 Min. On Time	0	
6	Ckt. #2 Min. On Time	0	
7	Ckt. #1 Min. On Time	8	

The 4 minute minimum off time is required to prevent short cycling of the compressor. The 8 minute minimum on time is recommended for efficiency. Minimum On times of less than 6 minutes are not recommended.

4. For the load schedule shown in Section 12, part A-3B, the following system definition program is recommended:

Selected Load Control Strategy: Fixed Priority
 System Assumptions: 8 Relays installed
 Heating System: 4 Circuits, 2 Heat Pumps with Electric Forced Air Furnaces.
 Hot Water Heater and Dryer Connected to Unit. 2 Circuits.
 2 Heat Pump Compressors Connected to Unit on Circuits #1 and #2.

"LIMIT" DISPLAY		"ACTUAL" DISPLAY	
QUESTION #	QUESTION:	ANSWER:	
0	# of loads not connected:	0	
1	# of rotating loads:	0	
2	Ckt. #3 Min. Off Time	0	
3	Ckt. #2 Min. Off Time	5	
4	Ckt. #1 Min. Off Time	5	
5	Ckt. #3 Min. On Time	0	
6	Ckt. #2 Min. On Time	10	
7	Ckt. #1 Min. On Time	10	

The 5 minute minimum off time is required to prevent short cycling of the compressors. The 10 minute minimum on time is recommended for efficiency. Minimum On times of less than 6 minutes are not recommended.

C. For applications assistance or additional information on the system definition programming mode, contact your SAVERGY representative or Synergetics International, Inc.